

VISION MEASURING SYSTEMS FOR SHOP-FLOOR AND LAB APPLICATIONS

SYLVAC VISIO **SWISS
MADE****Optical measurement for flat and revolving parts**

Discover our Sylvac-Visio V3 range with manual zoom, easy to use, easily accessible, competitive price, robust and stable for sectors such as medical, automotive, watch industry, pharma or cosmetics.

**Easy to use****3 types of lighting****Compare CAD function**

GENERAL FEATURES

SYLVAC-VISIO 200 & 300 V3

The search for Excellence is the philosophy that prevailed as the Sylvac VISIO V3 were designed based on advanced technologies that have contributed to make Sylvac optical systems a success.

The whole range is efficient, whilst also offering good value for money. Besides a cost effective price/performance ratio, these machines are fast, easy to learn and to use.

Each machine version has a granite structure, which provides the rigidity and stability required for any high-precision measuring system. Simplicity, effectiveness and reliability are key elements for this product range.

THE MACHINE RANGE

This range of manual machines feature a granite base and column, rigidly built, thereby guaranteeing outstanding stability.

Either equipped with a motorized or manual indexable zoom, their unique features meet the most demanding needs of industry making them a perfect universal multi-user inspection system.

ADVANTAGES

Attractive price

As High-Tech products, each SYLVAC-VISIO V3 offers a complete solution to problematic measurements of mechanical parts. Although these machines provide users with a high accuracy and high quality standard, their price makes them affordable and cost-effective.

Stability through stiffness

The granite structure ensures the stability required for every high-precision measuring system.

Simple to use

All SYLVAC-VISIO V3 come equipped with SYLVAC-REFLEX Vista. This intuitive software tool is part of the SYLVAC software family, which aspires to be the reference for simplicity and affordability.

Easily and rapidly accessible

A half single day is enough for the user to learn and use these machines.



GENERAL FEATURES

3 TYPES OF LIGHTING

Each SYLVAC-VISIO V3 is equipped with three distinct light source, which can be set individually in the software.

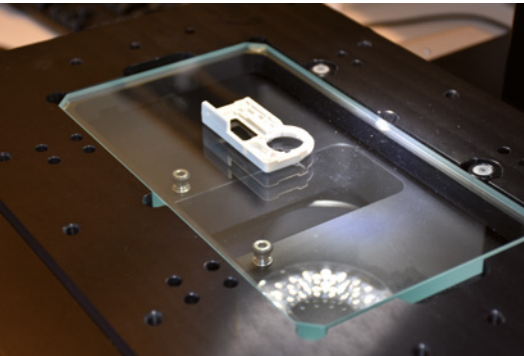

Episcopic illumination (ringlight)



Diascopic illumination (backlight)

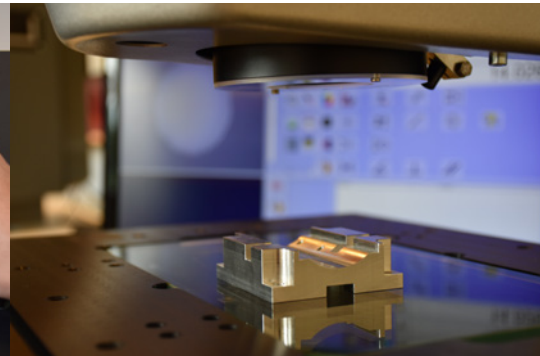

Coaxial light

Diascopic Illumination (backlight)

Transmitted light projected under the measured part. Useful for profile images or any measurement based on transparency.



Episcopic illumination (ringlight)

This incident light is particularly useful when inspecting millings, bores, chamfers or rounded edges. Depending on the chosen machine version, the segmented light allows directed lighting. It will vary as follow :

- SYLVAC-VISIO 200 V3: 1 row of 4 segments to 90°.
- SYLVAC-VISIO 300 V3 : 1 outer row of 8 segments to 45° plus 1 inner row of 4 segments to 90°.



Episcopic illumination (coaxial)

This light is projected from above through the zoom lens and allow a «view» through the light source. The light beams produce an illuminated field convenient for checking blind bores or cylindrical parts, but also for highly reflective materials. Optimized for large zoom values.

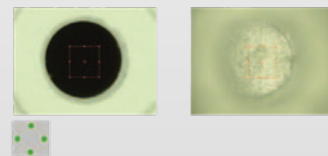

Parallel diascopic illumination (option)

This illumination is projected from the bottom using a special lens to create parallel light rays, so that multiple light reflections can virtually be eliminated. This results in sharp edges when measuring round parts.

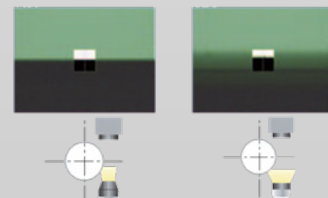

MAGNIFICATION

Indicative values for a 23.8" monitor with a 6,5x (0,7x to 4,5x) magnification, also with an additional lens.

		902.7100	902.7101	No lens	902.7102	902.7103
Lens		0.5x	0.75x	-	1.5x	2x
Magnifications		13 ÷ 79	20 ÷ 119	26 ÷ 158	40 ÷ 238	53 ÷ 317
Work distance (WD)	mm	175	113	92	51	36
Max. height (H)	mm	0 - 60	0 - 120	0 - 150	0 - 180	15 - 195
Max. field of view	mm	30.2 x 19	20.1 x 12.6	15.1 x 9.5	10 x 6.3	7.5 x 4.7
Min. field of view	mm	5 x 3.1	3.3 x 2.1	2.5 x 1.5	1.6 x 1	1.2 x 0.8

SOFTWARE

SYLVAC-REFLEX VISTA

Specially developed for use on every SYLVAC-VISIO machine, this software assists the operator throughout the measurement process of geometrical part features. Using the Compare option, the part can be visually checked against its related CAD model.



**FULL AUTONOMY
AFTER ONLY
1/2 DAY OF TRAINING**

Key features

- Linear compensation in all axes (calibration of X- and Y-axes at two levels, Z=0 and Z=150mm)
- Automatic calibration of the motorized zoom
- Direct setting of additional lenses
- Possible calibration of the lamps (linear control)
- Light track (constant illumination) for zoom control

Main capabilities

- Enhanced Z-measurement (throughout the field of view)
- Automatic measurement of circles and lines
- HTML configurable reports and directories
- 3D skew alignment option (3-2-1)

Comprehensive software

- User friendly graphical interface, touch-screen compatible
- Semi-Automatic playback of programs with operator guidance via directional compass pointer
- Compatible with multiple screens
- Functions control with the mouse scroll-wheel
- Polish, Russian and Portuguese as added languages to English, German, Chinese, Spanish, French, Italian and Japanese
- Light intensity permanently visible
- Machine calibration status continuously displayed
- Movable scrollbar for listed measured features
- Possible entry of characters for file names
- Automatic storage of all preference settings

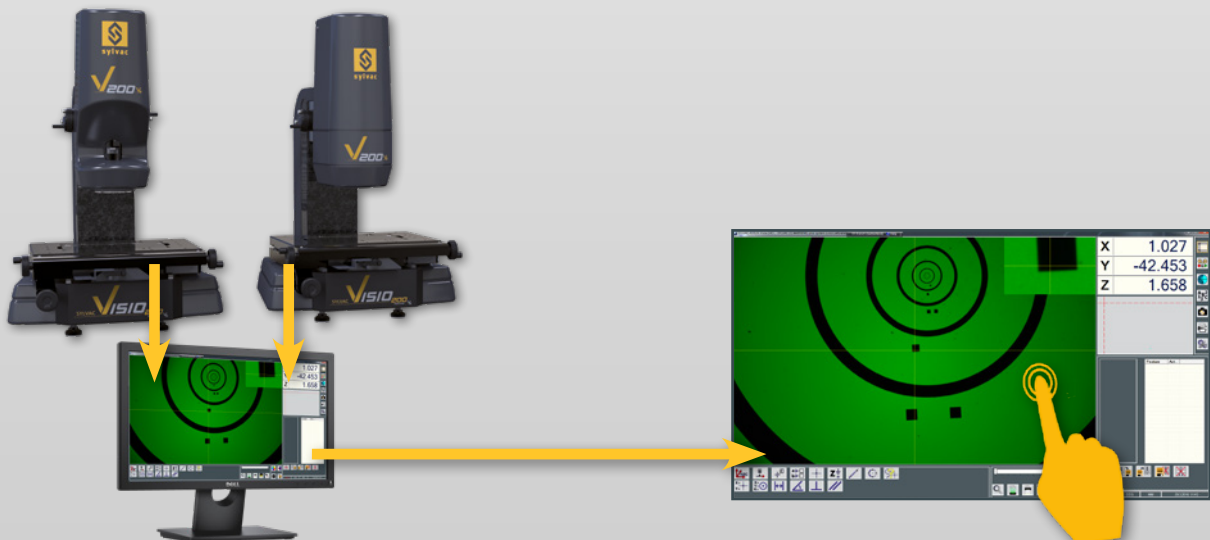

SYLVAC-VISIO 200 V3

- Highly stable granite structure
- Full-HD Camera
- New software layout with auto toggle screens live/schematics and touch compatible
- LED light sources
- Manual or motorized zoom
- Easy-to-use software tools



TECHNICAL SPECIFICATIONS

		902.2210	902.2211
		Sylvac VISIO 200 Manual zoom	Sylvac VISIO 200 Motorized zoom
Type		Manual	
Measuring volume (X,Y,Z)	mm	200x100x150	
Resolution	mm	0.001	
Resolution of incremental encoders	µm	0.05	
Fine adjustment in the Z-axis		✓	
Table surface (X/Y)	mm	400x280	
Glass plate thickness	mm	10	
Max. perm. load capacity	kg	10	
XY-Accuracy to MPE (E1, X,Y)	µm	1.9 + 10 L/1000 (L, mm)* / ***	
XY-Accuracy to MPE (E2, XY)	µm	2.4 + 10 L/1000 (L, mm)* / ***	
Z-Accuracy to MPE (E1, Z)**	µm	2.9 + 5 L/1000 (L, mm)	
Camera CMOS Full HD 2.3 Megapixels		✓	
Zoom		Manual 4x	Motorized 6x
Diascopic, episcopic and coaxial lights		✓	
Parallel diascopic light		Option	
Segmented ringlight, (4x90°), white LEDs		✓	
Segmented light, (4x90°+ 8x45°), white LEDs		-	
Weight	kg	98	

* m<5kg ** mechanical accuracy ***at glass level

DELIVERY

- Instrument according to technical specifications
- Softwares Sylvac-REFLEX Vista multilingual and CAD compare
- Computer, mouse, keyboard and touch screen 23.8"
- Windows 10 multilingual operating system
- Calibration certificate
- Manual

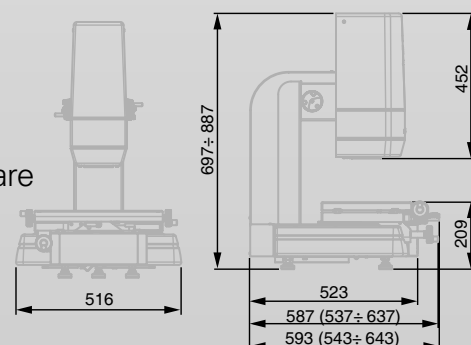

SYLVAC-VISIO 300 V3

- Highly stable granite structure
- Full-HD Camera
- New software layout with auto toggle screens live/schematics and touch compatible
- LED light sources
- Motorized zoom
- Easy-to-use software tools

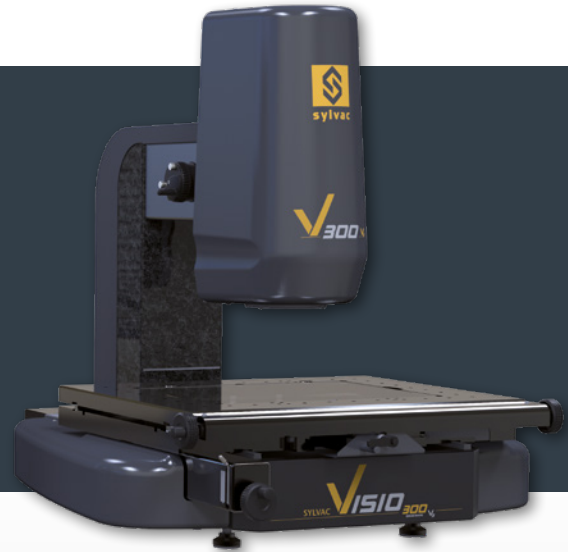

TECHNICAL SPECIFICATIONS

		902.2310
		Sylvac VISIO 300 Motorized zoom
Type		Manual
Measuring volume (X,Y,Z)	mm	300x200x150
Resolution	mm	0.001
Resolution of incremental encoders	µm	0.05
Fine adjustment in the Z-axis		✓
Table surface (XY)	mm	550x430
Glass plate thickness	mm	20
Max. perm. load capacity	kg	20
XY-Accuracy to MPE (E1, X,Y)	µm	1.9 + 4 L/1000 (L, mm)*/***
XY-Accuracy to MPE (E2, XY)	µm	2.4 + 4 L/1000 (L, mm)*/***
Z-Accuracy to MPE (E1, Z)**	µm	2.9 + 5 L/1000 (L, mm)
Camera CMOS Full HD 2.3 Megapixels		✓
Zoom		Motorized 6x
Diascopic, episcopic and coaxial lights		✓
Parallel diascopic light		Option
Segmented ringlight, (4x90°), white LEDs		-
Segmented light, (4x90°+ 8x45°), white LEDs		✓
Weight	kg	170

* m<5kg ** mechanical accuracy ***at glass level

DELIVERY

- Instrument according to technical specifications
- Softwares Sylvac-REFLEX Vista multilingual and CAD compare
- Computer, mouse, keyboard and touch screen 23.8"
- Windows 10 multilingual operating system
- Calibration certificate
- Manual

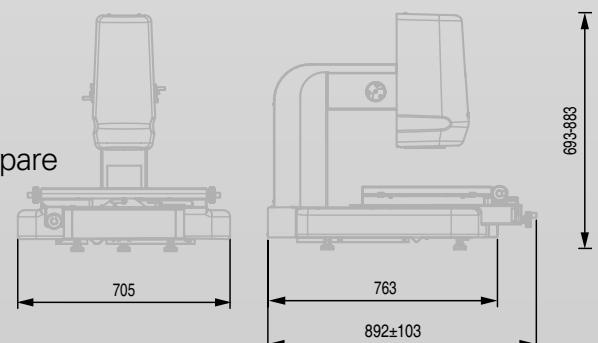

APPLICATIONS



PROFILE

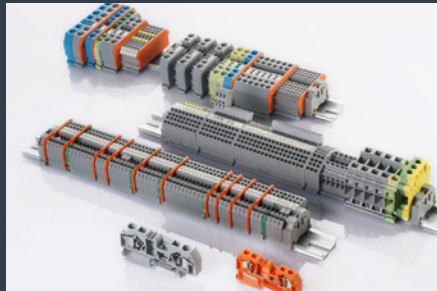
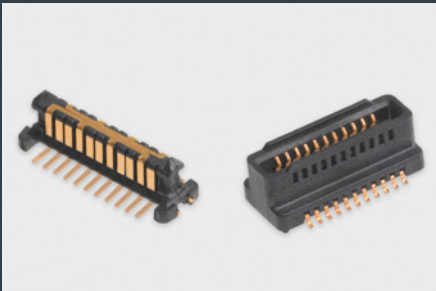

CONNECTORS



**PHONE
CONSUMER**



PLASTIC MOULDED

APPLICATIONS



DENTAL CARE



MEDICAL

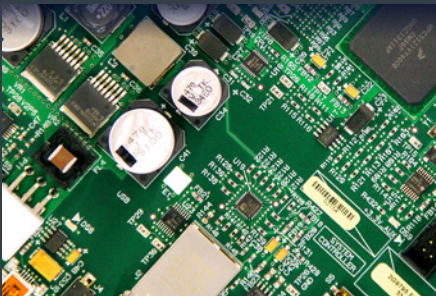

**ELECTRONIC,
PCB**



AUTOMOTIVE

APPLICATIONS



TECHNICAL PARTS



**WATCH
INDUSTRIES**



COSMETICS



PHARMA

ACCESSORIES



Order number	Description	Visio 200 V3	Visio 300 V3
902.7370	Diascopic illumination, parallel light	✓	✓
902.7100	Additional lens, 0,5x for zoom 6,5x	✓	✓
902.7101	Additional lens, 0,75x for zoom 6,5x	✓	✓
902.7102	Additional lens, 1,5x for zoom 6,5x	✓	✓
902.7103	Additional lens, 2x for zoom 6,5x	✓	✓
902.7380	Footswitch for value capture	✓	✓
902.7390	Sylvac-Reflex Vista COMPARE	✓ Standard delivery	✓ Standard delivery

ACCESSORIES



Order number	Description	Visio 200 V3	Visio 300 V3
902.7300	<p>Basic fixtures Kit :</p> <ul style="list-style-type: none"> • 1x Quick-Load Corner Fixture (QLC) • 1x 13mm x 150mm x 150mm R&R Acrylic Multi-Hole Fixture Plate • 1x (3) Dowel Pins • 3x 6mm Dia. x 10 and x 25mm Standoff • 3x 9mm Dia. x 5, x 10, x 20 and x 25mm Standoff • 3x 12mm Dia. x 10 and x 25mm Standoff • 2x 6mm Dia. x 10mm Pin Standoff • 2x 9mm Dia. x 10mm Pin Standoff • 2x 40mm Tension Clamp with Rubber Coated Tip • 2x 25mm Wire Clamp with Rubber Coated Tip • 2x 50mm Wire Clamp with Rubber Coated Tip • 4x Aluminium Resting Pin with M4 Thread • 1x 50mm x 50mm Corner Viewer for M4 • 1x 9mm Dia. Adjustable Jackstand with M4 Thread • 1x M4 Pusher Clamp • 1x 30mm and 1x 45mm Long Adjustable Slide with M4 Thread • 1x M4 Tower Block • 1x Micro-Clamp Vise with Base for M4 Components • 1x 12mm Dia. x10mm Spring Pusher Standoff Clamp • 1x 300mm x 190mm x 25mm Component Tray to Hold M4 Components* 	✓	✓
902.7301	<p>Advanced fixtures Kit :</p> <p>All Basic fixtures kit added with :</p> <ul style="list-style-type: none"> • 3x 6mm Dia. x 5, x 10 and x 25mm Standoff • 3x 9mm Dia. x 10, x 20, x 25mm Standoff • 3x 12mm Dia. x 10, x25mm Standoff • 2x 6mm Dia. x 10mm Pin Standoff • 2x 9mm Dia. x 10mm Pin Standoff • 4x 12mm Dia. x 10mm Pin Standoff • 2x 40mm Tension Clamp with Rubber Coated Tip • 2x 25mm Wire Clamp with Rubber Coated Tip • 2x 50mm Wire Clamp with Rubber Coated Tip with 50mm Post • 1x 9mm Dia. Adjustable Jackstand with M4 Thread • 1x 30mm and 1x 45mm Long Adjustable Slide with M4 Thread • 1x Base 16mm Sq x 19mm (for M4 Tower Block)* 	✓	✓
902.7104	<p>Fresnel kit 0.5x :</p> <p>Fresnel lens 152mm + lens 0.5x + fixation screws (for Ringlight)</p>	✓	
902.7105	<p>Fresnel kit 0.75x :</p> <p>Fresnel lens 101mm + lens 0.75x + fixation screws (for Ringlight)</p>	✓	
902.7106	<p>Fresnel kit 1.5x :</p> <p>Fresnel lens 40mm + lens 1.5x + fixation screws (for Ringlight)</p>	✓	

*for more details, consult our fixtures kits document on our website

INSTRUMENT

Manual zoom

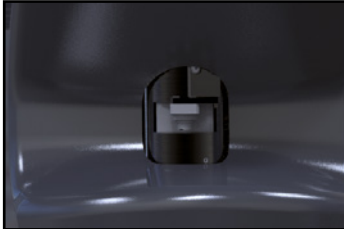

Quick release



3 types of lighting



Granite structure

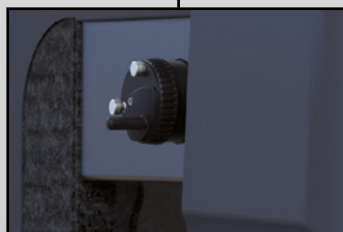

Z-Axis fine adjust

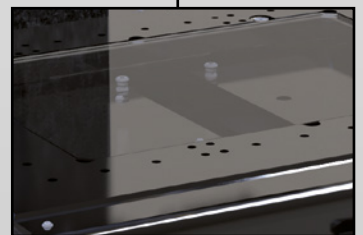

Glass table with fixing holes